

## ULTRA PANEL SERIES

**Flush Panel**

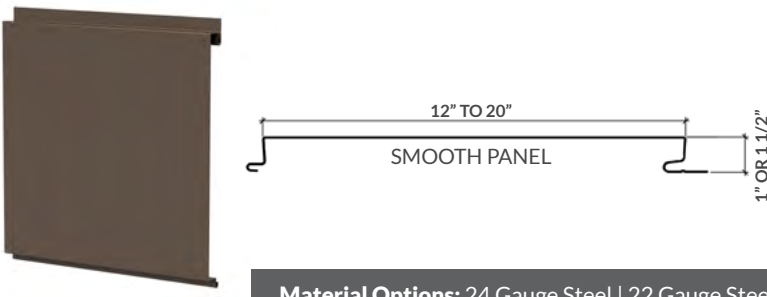

- Leveled for Flatness
- Available with up to Two Pencil Ribs
- Rounded Interlock Leg Provides Improved Flush Fit
- 40-Year Limited Finish Warranty
- Panel Lengths from 4' to 25'
- Optional Concealed Clips are Available for Added Wind Resistance
- Available with Venting

**Material Options:** 24 Gauge Steel | 22 Gauge Steel | .032 Aluminum | .040 Aluminum | Galvalume Plus

**Flush RV Panel**

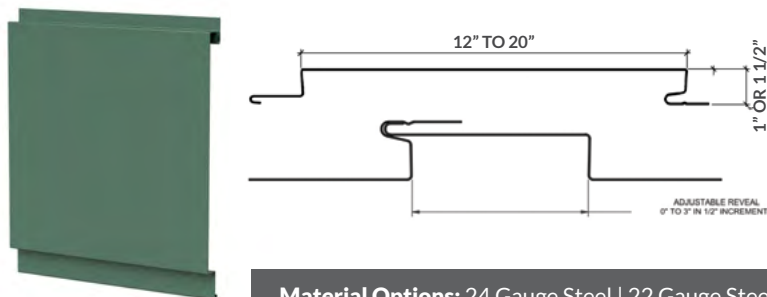

- Leveled for Flatness
- Available with up to Two Pencil Ribs
- Rounded Interlock Leg Provides Improved Flush Fit
- 40-Year Limited Finish Warranty
- Panel Lengths from 4' to 25'
- Optional Concealed Clips are Available for Added Wind Resistance
- Available with Venting

**Material Options:** 24 Gauge Steel | 22 Gauge Steel | .032 Aluminum | .040 Aluminum | Galvalume Plus

**Contour Panel**

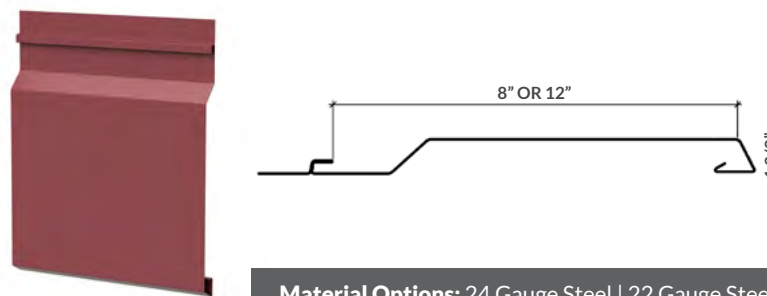

- Optional Clip Installation for Expansion/Contraction
- Cost-Effective Installation
- Horizontal or Vertical Installation
- 40-Year Limited Finish Warranty
- Panel Lengths: 30' Max for Steel, 25' Max for Aluminum on the thru-fastened leg; longer length available on clip panel

**Material Options:** 24 Gauge Steel | 22 Gauge Steel | .032 Aluminum | .040 Aluminum | Galvalume Plus

**Wave Panel**

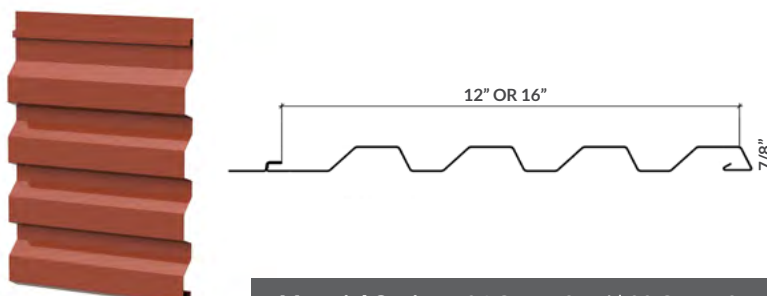











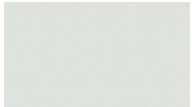



















- Optional Clip Installation for Expansion/Contraction
- Cost-Effective Installation
- Horizontal or Vertical Installation
- 40-Year Limited Finish Warranty
- Panel Lengths: 30' Max for Steel, 25' Max for Aluminum on the thru-fastened leg; longer length available on clip panel

**Material Options:** 24 Gauge Steel | 22 Gauge Steel | .032 Aluminum | .040 Aluminum | Galvalume Plus

Note: Oil canning is not a cause for rejection.

# ULTRA PANEL SERIES COLOR CHART

## Standard Finishes

				
Solar White	Regal White	Stone White	Surrey Beige	Sierra Tan
				
Sandstone	Ash Gray	Dove Gray	Slate Gray	Charcoal Gray
				
Burnished Slate	Medium Bronze	Mansard Brown	Dark Bronze	Matte Black
				
Terra Cotta	Colonial Red	Regal Red*	Burgundy*	Patina Green
				
Hemlock Green*	Hartford Green*	Evergreen	Slate Blue	Regal Blue*
				
Vintage®*	Pre-Weathered Galvalume®*	Cor-Ten AZR RAW®*	Silver*	Copper*
				
Champagne*	Acrylic-Coated Galvalume®			

## Textured Low-Gloss (TLG) PVDF Colors

				
TLG Moonstone™*	TLG Charcoal Gray*	TLG Medium Bronze*	TLG Dark Bronze*	TLG Black*

\*Available at a slight price premium. \*Metallic premium. \*Weathered premium